



Description

The K6 is a small trapezoidal two way loudspeaker, studio quality, designed to be used in a wide variety of audio applications as a small sound reinforcement unit. It houses a 6 1/2" driver and a tweeter. The construction is birch plywood and it is painted in texture black finish.

Applications

The K6 is suitable to perform background music for installations such as pubs, restaurants, discos...

FRONT

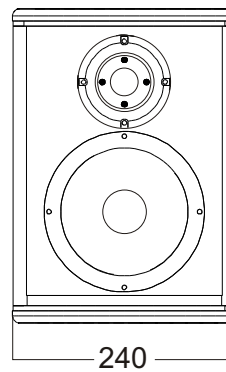

RIGHT

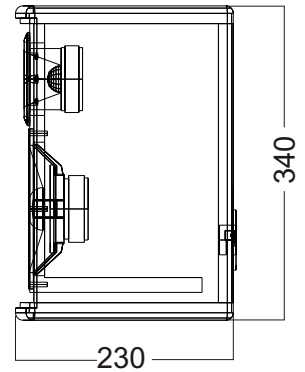

BACK

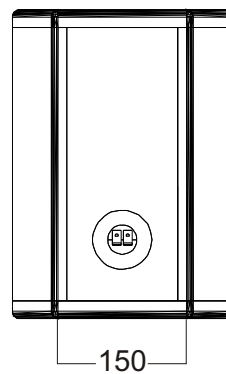

TOP

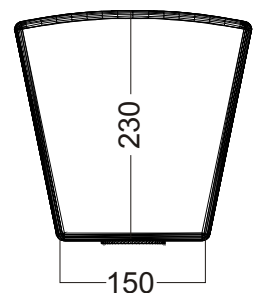

TECHNICAL SPECIFICATIONS

Frequency Response (Hz)	90 Hz-20 KHz \pm 3dB
Power Handling (Watts)	100 W RMS
Sensitivity	91 dB (1w/1m)
Nominal peak	109 dB
Coverage angle	60x60
Crossover	3 kHz passive assymetrical
Impedance	8 Ohm
Drivers	1X6" +tweeter
Connectors	push terminal
Dimensions	34x24f/15rx23 cm (HxWxD)
Weight	4 Kg

DIAGRAMS

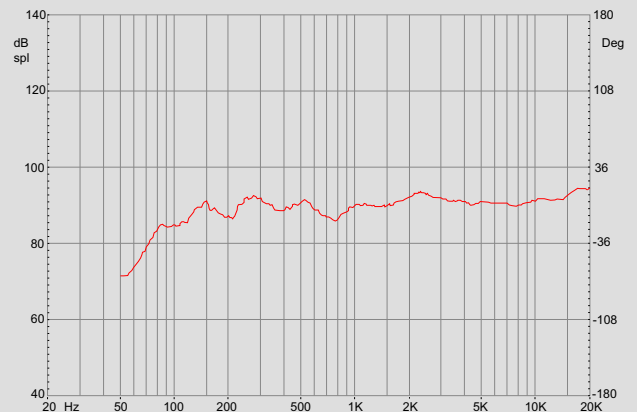

FREQUENCY RESPONSE CURVE

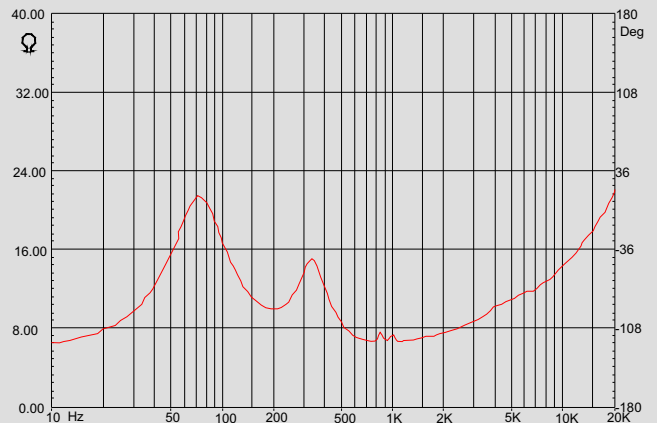

IMPEDANCE CURVE

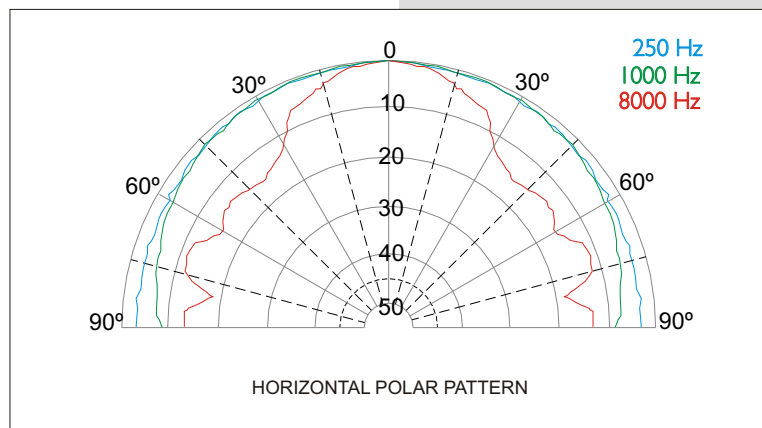

HORIZONTAL POLAR PATTERN



tecnare
SOUND SYSTEMS

Is a™ Designed and manufactured in Spain by



Pº Ind. Monte Boyal. C/Encinar 282
 45950 Casarrubios del Monte (Toledo). SPAIN.
 Phone: +34 918 170 110
 Fax: +34 918 183 053
 www.tecnare.com
 exel@tecnare.com